

konwi[®] intercom



konwi[®]
vision

konwi[®]
2T



konwi[®]
pass

0850 255 1219
www.konwiintercom.com.tr

2023

CATALOG

KONWI INTERCOM 2 WIRE VIDEO & AUDIO SYSTEM - 2T

2T	CODE	DESCRIPTION	PRICE	CARTOON	
	1204430	Konwi 2T 4.3" Monitor - WHITE		48	
	1204437	Konwi 2T 4.3" Monitor - BLACK		48	
	1204700	Konwi 2T 7" Monitor - WHITE		32	
	1203120	Konwi 2T Outdoor Station		20	
	1203125	Konwi 2T Outdoor Station - BLACK		20	
	1203126	Konwi 2T Outdoor Station - INOX		20	
	1203140	Konwi 2T Outdoor Stationi 4-LINE LCD		20	
	1202101	Konwi 2T VILLA Outdoor Station - Single Button		24	
	1202102	Konwi 2T VILLA Outdoor Station - Twin Button		24	
		1205052	Konwi 2T Junction Distributer - 2 Out ***Page-8***		50
		1205054	Konwi 2T Colon Seperator - 4 Out ***Page-8***		25
		1203095	Konwi 2T Power Supply With Seperator 40W		100
		1203093	Konwi 2T Power Supply (over20flat) 60W		80
		1206091	Konwi 2T Separator (use with power supply)		25

Lower Than 20 Flats 2X0.75 Cooper Cable, More Than 20 Flats Buildings, 2X1.5mm Copper Cable Usage Advised



1203095



1205054



1205052

KONWI INTERCOM 6 WIRE VIDEO & AUDIO SYSTEM - VISION-S

Vision-S	CODE	DESCRIPTION	PRICE	CARTOON	
	1134430	Konwi VisionS 4.3" Monitor - WHITE		48	
	1134437	Konwi VisionS 4.3" Monitor - ANTHRACITE		48	
	113443X	Konwi VisionS 4.3" Monitör - Pearl, Dore, Silver, Gold, Dark Green		48	
	1134700	Konwi VisionS 7" Monitor - WHITE		32	
	1133100	Konwi VisionS Outdoor Station		12	
	1133125	Konwi VisionS Outdoor Station - BLACK		12	
	1133126	Konwi VisionS Outdoor Station - INOX		12	
	1133140	Konwi VisionS Outdoor Station 4-LINE LCD		12	
	1132101	Konwi VisionS VILLA Outdoor Station - Single Button		24	
	1132102	Konwi VisionS VILLA Outdoor Station - Twin Button		20	
		1133094	Konwi Intercom Power Supply 40W		100
		1133096	Konwi Intercom Power Supply 60W		80
		1133099	Konwi Intercom Power Supply 90W		50
	1115041	Konwi VisionS Junction Distributer 4-Out		25	
	1115042	Konwi VisionS Video Amplificator 4-Out		10	
	1115044	Konwi VisionS Combo (Amplificator&Distributer) 4+4 Out		10	
	1113145	Konwi VisionS 45 Degree Outdoor Station Turning Device		10	
	1113146	Konwi VisionS Mounting Pad + Rain Jacket		10	
	1135510	Konwi VisionS Securitiy Concole		1	

Replace X with= 4.3" TFT Monitor Color Choice:: White=0, Pearl=2, Silver=3, Gold=4, DORE=5, Dark Green=6, ANTHRACITE=7

1115044

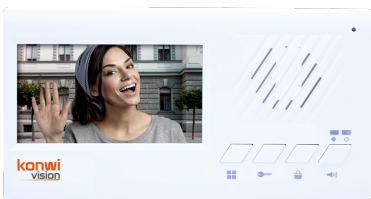

1115041

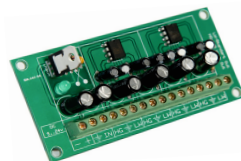

1115044

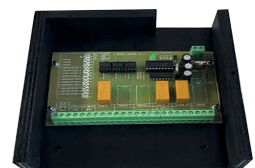

1115610

KONWI INTERCOM 6 WIRE - 2 WIRE SYSTEM SET PRICE

VISION-S 6WIRE SET PRICES			2T 2WIRE SET PRICES		
FLAT QTY	PRICE	FLAT QTY	PRICE	FLAT QTY	PRICE
1		41		1	
2		42		2	
3		43		3	
4		44		4	
5		45		5	
6		46		6	
7		47		7	
8		48		8	
9		49		9	
10		50		10	
11		51		11	
12		52		12	
13		53		13	
14		54		14	
15		55		15	
16		56		16	
17		57		17	
18		58		18	
19		59		19	
20		60		20	
21		61		21	
22		62		22	
23		63		23	
24		64		24	
25		65		25	
26		66		26	
27		67		27	
28		68		28	
29		69		29	
30		70		30	
31		71		31	
32		72		32	
33		73		33	
34		74		34	
35		75		35	
36		76		36	
37		77		37	
38		78		38	
39		79		39	
40		80		40	

FOR COLOR MONITOR SET PRICE: Add the price of the color and white differences upto your flat quantity

ADD SET PRICE :

- 1.) After calculate the set total price for the one building, seperator or distributor should be add to system price accordin
- 2.) If it is required, for apartment staff ; one more indoor monitor can be add to total system. Each indoor monitor can for requests.

DIMENSION:

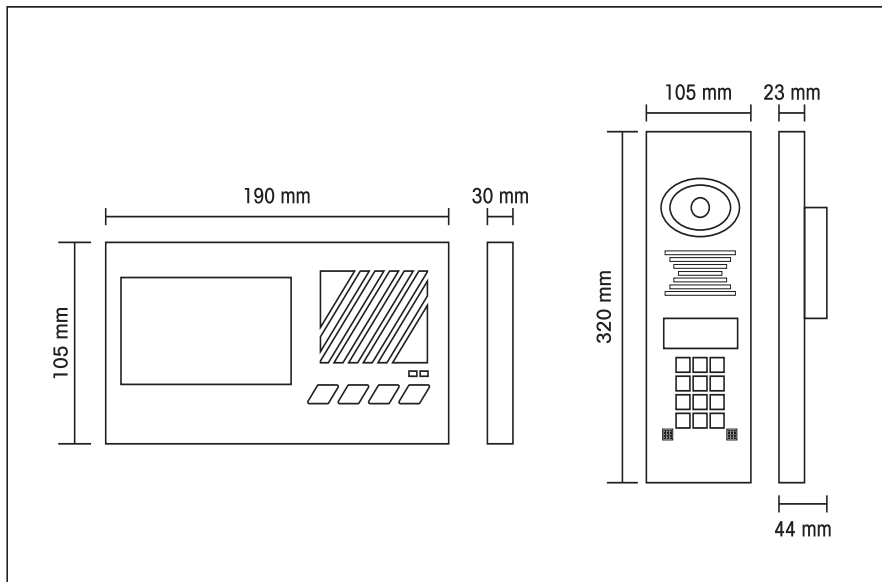

KONWI INTERCOM 8+N WIRE AUDIO SYSTEM

	CODE	DESCRIPTION	PRICE	CARTOON
	1104001	Indoor Unit		72
	1104002	Indoor Unit with staff button		72
	1104032	Double Ring Santral		10
	1104132	Double Ring Big Santral (over 32 flats in one apartment)		10
	1104042	Double Ring Santral With Staff		10
	1104142	Double Ring Big Santral With Staff		10

NOT: The system can be installed with santral and should be add outdoor panel one wire for each flat

KONWI INTERCOM 5 WIRE DIGITAL CODDING AUDIO SYSTEM

	CODE	DESCRIPTION	PRICE	CARTOON
	1105001	Digital Kapıcısız Daire Ünitesi		72
	1105002	Digital Kapıcılı Daire Ünitesi		72
	1103100	Digital Şifrematikli LCD Ekranlı Zil Paneli		12
	1133094	Konwi Intercom Güç Kaynağı 40W		100

NOT: The system can be installed without santral. Just should be connected to outdoor station with 5 wire, no need extra cable for each flat

*** This system can be used with Vision-S 6-wire video system together ***

KONWI INTERCOM 8+N WIRE AUDIO SYSTEM OUTDOOR STATION WITH BUTTON

SINGLE	CODE	DESCRIPTION *With Speaker*	PRICE	CARTOON
	1102101	1 Button Single Line Outdoor Station	
	1102102	2 Button Single Line Outdoor Station	
	1102103	3 Button Single Line Outdoor Station	
	1102104	4 Button Single Line Outdoor Station	
	1102105	5 Button Single Line Outdoor Station	
	1102106	6 Button Single Line Outdoor Station	
	1102107	7 Button Single Line Outdoor Station	
	1102108	8 Button Single Line Outdoor Station	
	1102109	9 Button Single Line Outdoor Station	
	1102110	10 Button Single Line Outdoor Station	
	11021XX	ADD One Line For Each Flat	

SINGLE	CODE	DESCRIPTION *Without Speaker*	PRICE	CARTOON
	1102001	1 Button Single Line Outdoor Station	
	1102002	2 Button Single Line Outdoor Station	
	1102003	3 Button Single Line Outdoor Station	
	1102004	4 Button Single Line Outdoor Station	
	1102005	5 Button Single Line Outdoor Station	
	1102006	6 Button Single Line Outdoor Station	
	1102007	7 Button Single Line Outdoor Station	
	1102008	8 Button Single Line Outdoor Station	
	1102009	9 Button Single Line Outdoor Station	
	1102010	10 Button Single Line Outdoor Station	
	11020XX	ADD One Line For Each Flat	

DOUBLE	CODE	DESCRIPTION *With Speaker*	PRICE	CARTOON
	1102202	2 Button Double-Line Outdoor Station	
	1102204	4 Button Double-Line Outdoor Station	
	1102206	6 Button Double-Line Outdoor Station	
	1102208	8 Button Double-Line Outdoor Station	
	1102210	10 Button Double-Line Outdoor Station	
	1102212	12 Button Double-Line Outdoor Station	
	1102214	14 Button Double-Line Outdoor Station	
	1102216	16 Button Double-Line Outdoor Station	
	1102218	18 Button Double-Line Outdoor Station	
	1102220	20 Button Double-Line Outdoor Station	
	1102222	22 Button Double-Line Outdoor Station	
	1102224	24 Button Double-Line Outdoor Station	
	1102226	26 Button Double-Line Outdoor Station	
	1102228	28 Button Double-Line Outdoor Station	
	11022XX	ADD One Line For Each Two(2) Flat	

KONWI INTERCOM AL Bell Unit

	CODE	WITHOUT LIGHT	PRICE	CODE	WITH LIGHT	PRICE	CARTOON
	1101001	1 Button AL Bell Unit		1101201	1 Button AL Bell Unit		100
	1101002	2 Button AL Bell Unit		1101202	2 Button AL Bell Unit		66
	1101003	3 Button AL Bell Unit		1101203	3 Button AL Bell Unit		56
	1101004	4 Button AL Bell Unit		1101204	4 Button AL Bell Unit		43
	1101005	5 Button AL Bell Unit		1101205	5 Button AL Bell Unit		36
	1101006	6 Button AL Bell Unit		1101206	6 Button AL Bell Unit		32
	1101007	7 Button AL Bell Unit		1101207	7 Button AL Bell Unit		28
	1101008	8 Button AL Bell Unit		1101208	8 Button AL Bell Unit		20
	1101009	9 Button AL Bell Unit		1101209	9 Button AL Bell Unit		20
	1101010	10 Button AL Bell Unit		1101210	10 Button AL Bell Unit		20
	11010XX	ADD One Lide For Each Flat		11012XX	ADD One Lide For Each Flat	

KONWI INTERCOM DOOR BELL

	CODE	DESCRIPTION	PRICE	CARTOON
	1003501	Single Tone Canary - 12V AC		50
	1003502	Three Tone Canary - 12V AC		50
	1003503	Electronic Ding Dong (2 Battery)		50
	1003504	30 Tone Melody Bell (2 Battery)		50
	1003101	Intercom Unit (Staff Call)		50

KONWI INTERCOM BELL TRANSFORMERS (AC-AC)

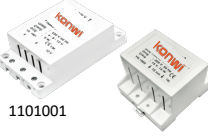
	CODE	DESCRIPTION	PRICE	CARTOON
	1001001	4V-8V-12V AC Transformer (5W) Without Track		50
	1001011	4V-8V-12V AC Transformer (5W) Track		50
	1001012	15W-15V AC Transformer Track		30
	1001013	15W-24V AC Transformer Track		30

KONWI INTERCOM ELECTRIC RIM DOOR UNLOCK

	CODE	DESCRIPTION	PRICE	CARTOON
	1005501	DOOR RIM UNLOCK WITH BUTTON		24
	1005502	DOOR RIM UNLOCK WITH KEY		12
	1005507	SMART RIM UNLOCK AUTOMATIC		12
	1005508	UNLOCK OPPOSITE		24
	1005510	SLIM UNLOCK OPENNER		24
	1003510	AUTOMATIC LIGHT PROGRAMMER		12

KONWI INTERCOM PASS MODULES - KONWI PASS

	CODE	DESCRIPTION	PRICE	CARTOON
	1005601	Password Pass 12/24V AC/DC		24
	1005602	RFID Card Pass 12/24V AC/DC		24
	1005603	Password & RFID Card Pass 12/24V AC/DC		24
	1005604	Hand Sensor 12/24V AC/DC		24
	1005605	WiFi Pass 12/24V AC/DC		24
	1005612	Smart Card		24
	1005613	Smart Key		24

NOT: ALL KONWI PASS Products:
Can be used with all KONWI Video & Audio Intercom Systems At The Same Time

WiFi Pass: Works with mobile phone to open door

KONWI INTERCOM WALLWASHER

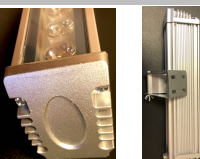
	CODE	DESCRIPTION	TEK R.	RGB
	950030X	3W 100MM WALLWASHER		
	950060X	6W 200MM WALLWASHER		
	950090X	9W 300MM WALLWASHER		
	950120X	12W 350MM WALLWASHER		
	950180X	18W 500MM WALLWASHER		
	950240X	24W 670MM WALLWASHER		
	950360X	36W 960MM WALLWASHER		

X: REPLACE FOR COLOR: X=0 White, X=1 Day Light, X=2 Amber, X=3 Blue, X=4 Red, X=5 Green, X=8 Mix, X=9 RGB

SERİ KABLO BAĞLANTI ŞEMASI
BASIC WIRING (NO VIDEO DISTRUBUTER OR AMPLIFIER)



NOT:

1. GÜÇ Kaynağı DC çıkışı: *Kırmızı Kablo: +, *Siyah Kablo: -
2. Sistemden gelen Kırmızı ve Mavi Kablolar Güç kaynağı Kırmızı kabloya (+) birlikte bağlanır. Sistemden gelen Beyaz Ve Yeşil Kablolar Güç kaynağı Siyah kabloya (-) kabloya birlikte bağlanır.

NOTE:

1. The output of power supply wire:
* RED WIRE: +
* BLACK WIRE: -
2. Connect the red and blue wires together from system and connect them to power supply red wire (+). Connect the white and green wires together fro system and connect them to power supply black wire (-).

GÜÇ KAYNAĞI
POWER SUPPLY

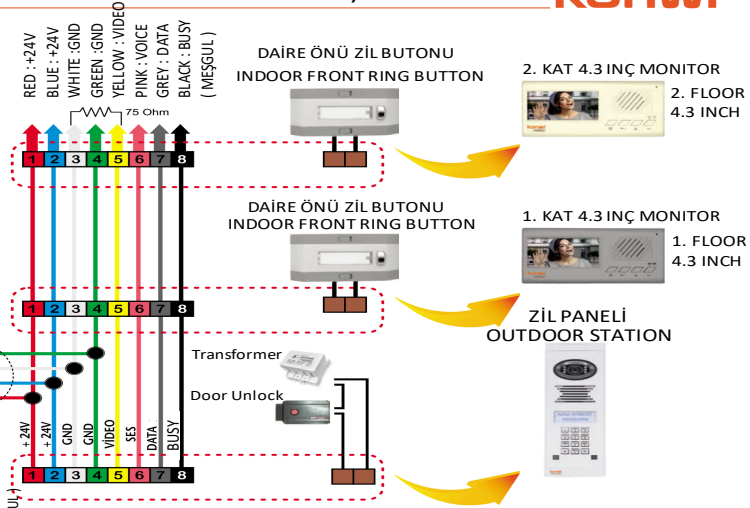

VIDEO DAĞITICI
ŞEMASI
VIDEO DISTRUBUTER
WIRING

BUAT KUTUSU
JUNCTION BOX

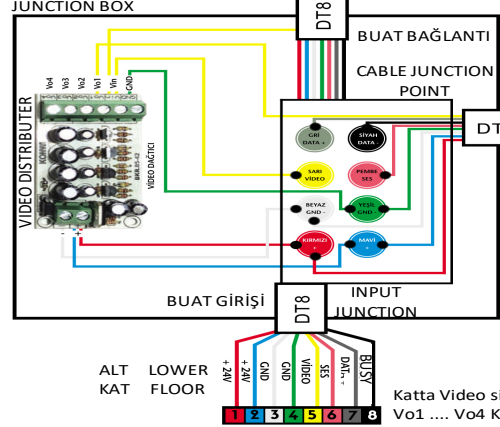

1. MONİTOR



1. KAT
BAĞLANTI

1. FLAT CABLE
WIRING

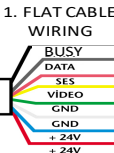

NOT:

1. Buat video bağlantısı yapılacaksa, katta her 4 daireye kadar bir video dağıtıcı kullanılabilir.
2. Video Dağıtıcı kullanılırken: "V in" giriş klemensine, bir önceki kattan gelen video sinyali kablosu (SARI RENK) BAĞLANIR. "V in" Klemensi ile Sarı Kablo bağlantısı dışında: Video dağıtıcıya yalnızca + ve - enerji hattı bağlanır. Ses, Data ve Mesgul kabloları bağlanmaz.
3. Bina tesisatında kullanılan son video dağıtıcıda, jumper pozisyonu 75 Ohm olacak şekilde konumlandırılır.
4. Video Dağıtıcı yandaki şekildedeki gibi bağlanır. Kırmızı ve mavi kablolar; video dağıtıcı üzerindeki "+" klemensine, beyaz kablo ise, video dağıtıcı üzerinde "-" klemensine bağlanır. Yeşil kablo ise dağıtıcı üzerinde "GND" klemensine bağlanır.

NOTE:

1. If make wiring with junction, use 1 video distributor for each 4 flat.
2. While wiring of junction model: there is "V in" terminal on video distributor, connect video cable (yellow) of system on this terminal; which comes from one lower floor and continue to upper floor. Except "V in" terminal: no other terminal on video distributor connect with lower or upper floor cables.
3. On the last video distributor, the jumper position of video distributor should be setup 75 Ohm.
4. Connect video distributor wires as left draw. Red and blue wires of system connect to distributor "+" terminal, white wire of system connect to "-" terminal of distributor, green wire of system connect to "GND" terminal of distributor.

Katta Video sinyalini dağıtmak için: video dağıtıcıdaki bu (Vo1 Vo4) klemensleri kullanınız. Vo1 Vo4 Klemensleri yardımı ile dairelere video sinyali gönderilir.

Yellow video wire for flat: use distributor terminals (Vo1 Vo4) to connect video wire to flats.

NOT:

TEK kolonlu binalarda, 8 renkli diafon kablosu güç iletiminde yetersiz kalmaktadır. Bu yüzden, +24 ve GND uçlarına paralel, 2x0.75 bakır kablo çekilmesi tavsiye edilir.

FLATNO	SWITCH NO								FLATNO	SWITCH NO								FLATNO	SWITCH NO								FLATNO	SWITCH NO							
	1	2	3	4	5	6	7	8		1	2	3	4	5	6	7	8		1	2	3	4	5	6	7	8		1	2	3	4	5	6	7	8
KAPICI									DAİRE-25									DAİRE-50									DAİRE-75								
DAİRE-1									DAİRE-26										DAİRE-51									DAİRE-76							
DAİRE-2									DAİRE-27										DAİRE-52									DAİRE-77							
DAİRE-3									DAİRE-28										DAİRE-53									DAİRE-78							
DAİRE-4									DAİRE-29										DAİRE-54									DAİRE-79							
DAİRE-5									DAİRE-30										DAİRE-55									DAİRE-80							
DAİRE-6									DAİRE-31										DAİRE-56									DAİRE-81							
DAİRE-7									DAİRE-32										DAİRE-57									DAİRE-82							
DAİRE-8									DAİRE-33										DAİRE-58									DAİRE-83							
DAİRE-9									DAİRE-34										DAİRE-59									DAİRE-84							
DAİRE-10									DAİRE-35										DAİRE-60									DAİRE-85							
DAİRE-11									DAİRE-36										DAİRE-61									DAİRE-86							
DAİRE-12									DAİRE-37										DAİRE-62									DAİRE-87							
DAİRE-13									DAİRE-38										DAİRE-63									DAİRE-88							
DAİRE-14									DAİRE-39										DAİRE-64									DAİRE-89							
DAİRE-15									DAİRE-40										DAİRE-65									DAİRE-90							
DAİRE-16									DAİRE-41										DAİRE-66									DAİRE-91							
DAİRE-17									DAİRE-42										DAİRE-67									DAİRE-92							
DAİRE-18									DAİRE-43										DAİRE-68									DAİRE-93							
DAİRE-19									DAİRE-44										DAİRE-69									DAİRE-94							
DAİRE-20									DAİRE-45										DAİRE-70									DAİRE-95							
DAİRE-21									DAİRE-46										DAİRE-71									DAİRE-96							
DAİRE-22									DAİRE-47										DAİRE-72									DAİRE-97							
DAİRE-23									DAİRE-48										DAİRE-73									DAİRE-98							
DAİRE-24									DAİRE-49										DAİRE-74									DAİRE-99							

NOTE:

1. FOR Apartment Staff Coddng all switches should be OFF position.
2. While Password Adjustment, dont choose "9999"

OUTDOOR STATION ADJUSTMENTS:

1. Password & Master Code Adjustment: to choose Password Or Master Code; # * 2580 push. # push for continue and save.
2. To Unlock Door; Push * * & 4 step unlock password
NOTE: Fory Unlock Password is: * * 1234

konwi[®] intercom



KONWI 2T 2-WIRE WIRING SYSTEM

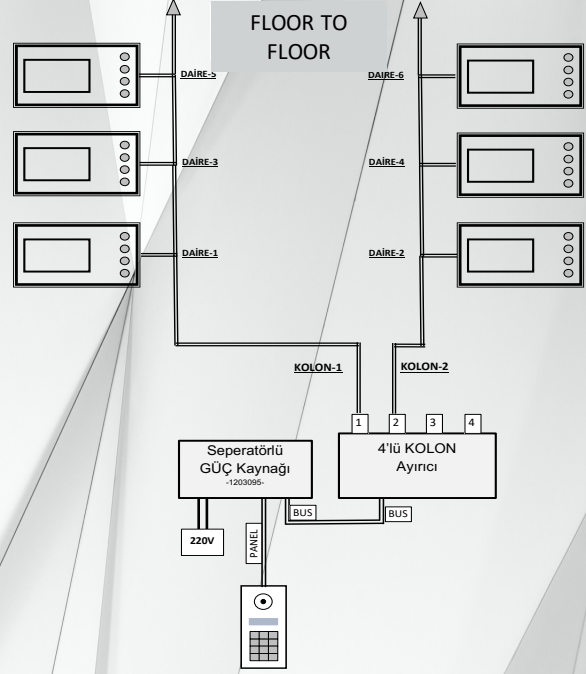

SINGLE COLON WIRING

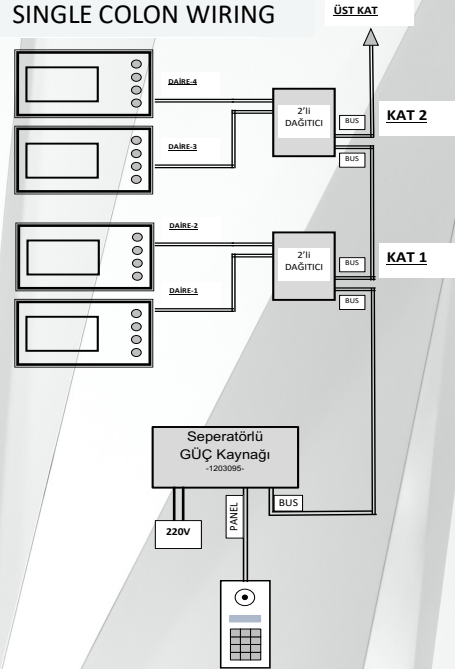

2023
FİYAT LİSTESİ

YÜCPA ELEKTRONİK VE YAZILIM
TEKNOLOJİLERİ SAN.TİC.LTD.ŞTİ
Esenler / İstanbul

0850 255 1219

www.konwiintercom.com.tr